

JB SANITARY

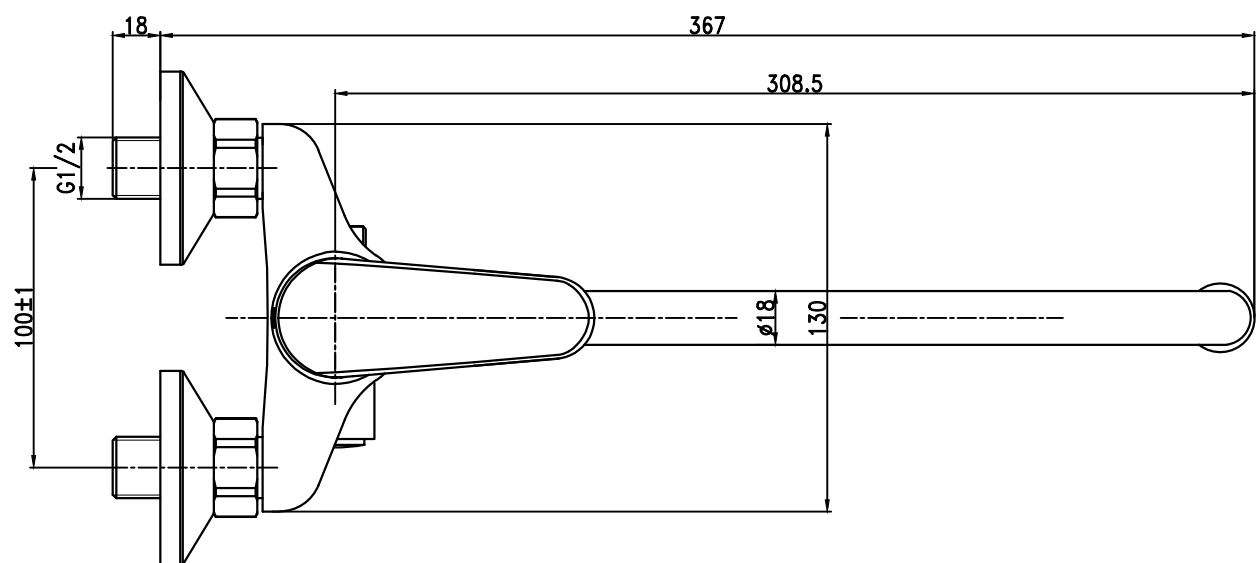
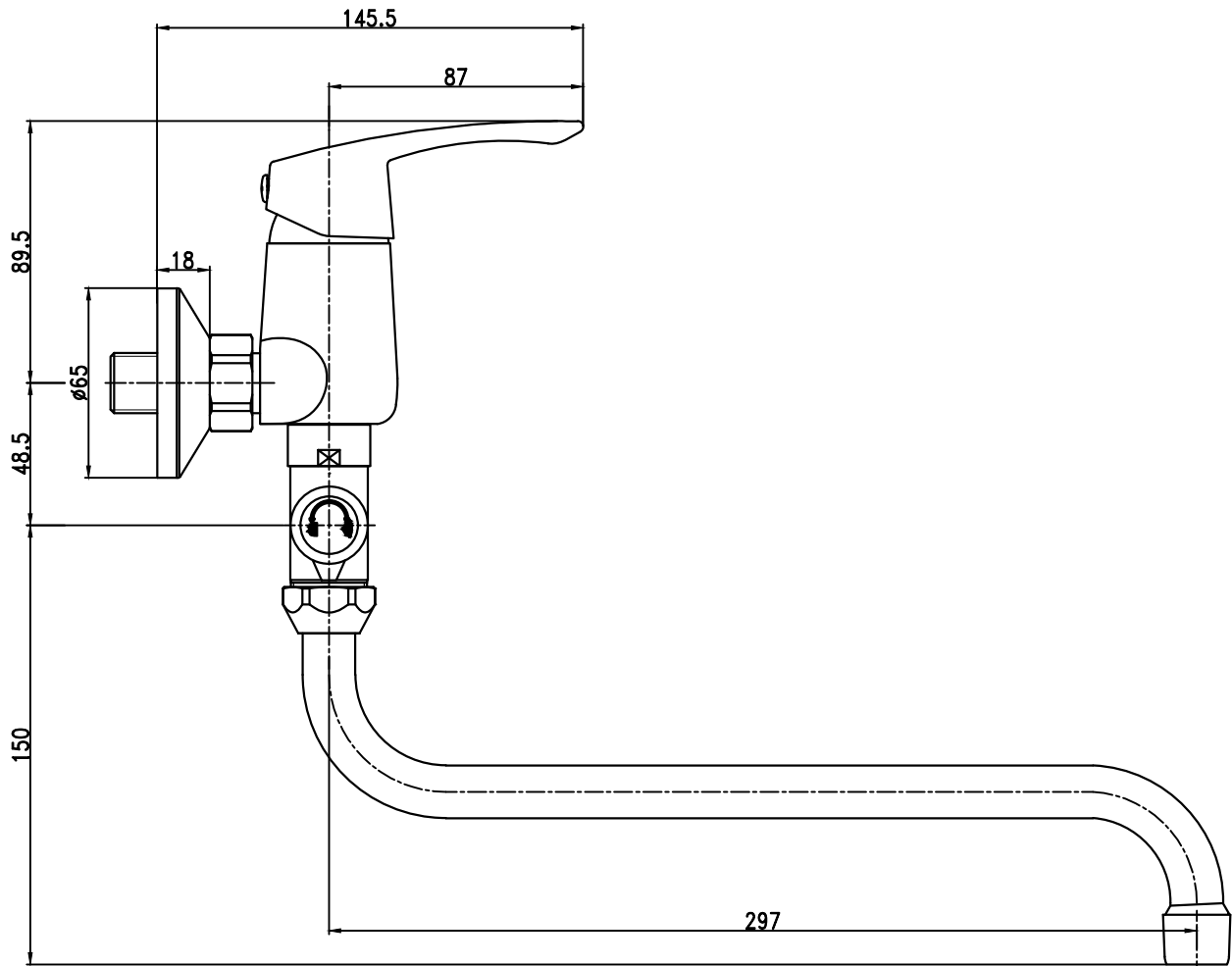

L10 32 50